



MarsEVOL



PARSYS PRO

▶ For indoor / single or multi-layer

Product Features:

- Unique spectrum design, applicable for different growth stages of Clone, mother, vegetative and flowering or whole stage of different plants.
- Model 310W for Vegetative stage, model 620W for propagation, veg. and flowering full growth stage, coverage area 4'x4' and 5'x5', better lighting uniformity
- High lighting transmittance tempered glass + aluminum alloy design, super protection, sunlight-resistant, chemicals-resistant, 95% lighting transmittance rate

-  Protection Level: IP66
-  Beam Angle: 110°
-  Warranty: 5 Year
-  Dimming Type: 0/1-10V



CB CE RoHS

— MarsEVOL LIGHTING

PRODUCT SPECTRUM

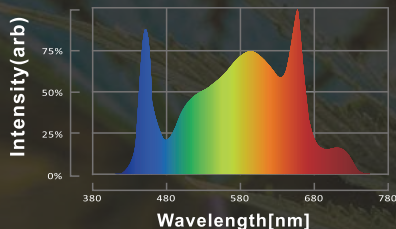

Full spectrum with deep red peak.
Contains wavelengths between 400-700nm.
Drastically enhance energy at 660nm. Meantime,
supplement the energy at 730nm. Better growth for flowering plants.





PRODUCT PARAMETER DETAILS

	Type NO.	Power	Efficiency	PPF	Dimming	BTU	Spectrum	Voltage	LED
North America	380-0016	640W	2.4 μ mol/J	1536 μ mol/s	1-10V	2183.8	FS-Flow	100-277VAC	Samsung White + Osram Red Osram Far Red
Europe	380-0019	620W	2.4 μ mol/J	1488 μ mol/s	0-10V	2115.5	FS-Flow	100-240VAC	Samsung White + Osram Red Osram Far Red

AMPERAGE BY VOLTAGE OVERVIEW

		VOLTAGE(AC)	120V	208V	230V	277V	348V	480V
AMPERAGE	North America	380-0016	5.33A	3.08A	/	2.31A	/	/
	Europe	380-0019	/	/	2.70A	/	/	/

PLUGS AT DIFFERENT VOLTAGES

North America	125V	250V	277V		Europe	230V
	5-15P	6-15P	7-15P	L7-15P		
						

PRODUCT DIMENSIONS

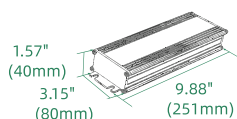

North American

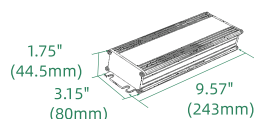

Europe

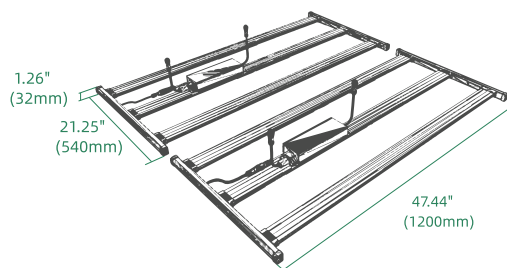

Body: Aluminum+PC Weight: 66.14lb/30kg
Package Dimensions: 51.18"x22.05"x11.02"(1300X560X280mm) [3 sets (6 modules)]

APPLICATION SCENARIOS



North America Version Power Cable 6.56' 5-15P 125V (380-A-0001)



Europe Version Power Cable 2m (380-A-0030)



North America Version Dimming Power Cable 6.56' (380-A-0002)



Europe Version Dimming Power Cable 2m (380-A-0004)



North America Version Power Cable 6.56' 5-15P 250V (380-A-0005)



Europe Version Pigtail Power Cable 2m (380-A-0032)



Stainless clips for suspending installation(1set=4pcs) (380-A-0012)



Clips for driver installation(1 pair) (380-A-0016)



Suspending connection kits for double modules (2 pcs interconnection stainless clips, 4 pcs stainless clips, 2 pcs 16.4' (5m) adjustable stainless lifting cable)(380-A-0035)

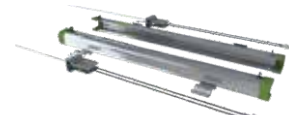

Suspending connection kits for double modules (2 pcs interconnection stainless clips, 4 pcs stainless clips, 2 pcs 16.4' (5m) adjustable steel wire lifting rope with pulley (380-A-0034)

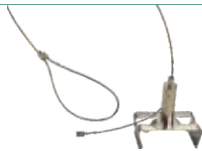

Adjustable installation kits suitable for shelves(380-A-0014)



Waterproof end cap for Dimming T-shape junction cable(380-A-0021)



Waterproof end cap for Dimming power cable(380-A-0022)



Hook for driver install on the shelves (1 pair)(380-A-0025)

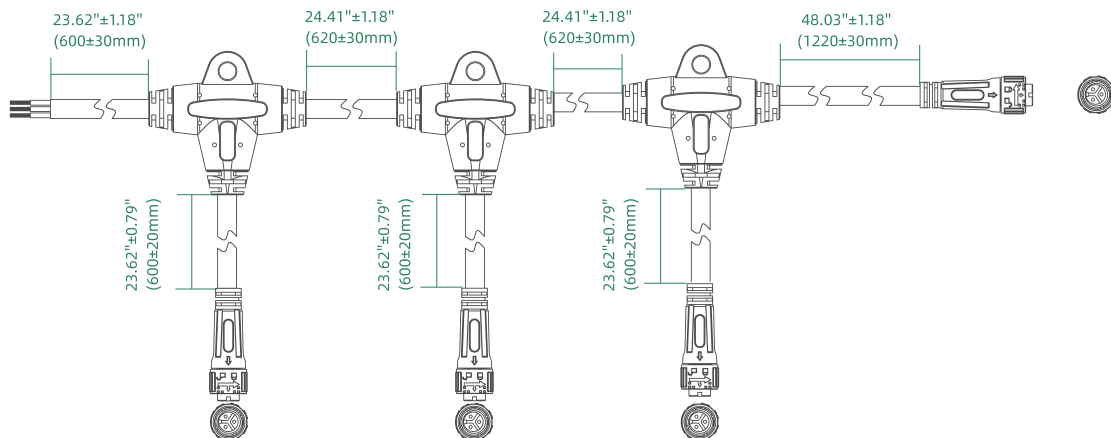

North America version Power T-shape junction cable, 3pin, 1 sub-4 power interconnection cable, totally 10.82'(380-A-0007)
Europe version Power T-shape junction cable, 3pin, 1 sub-4 power interconnection cable, totally 3.3m(380-A-0009)

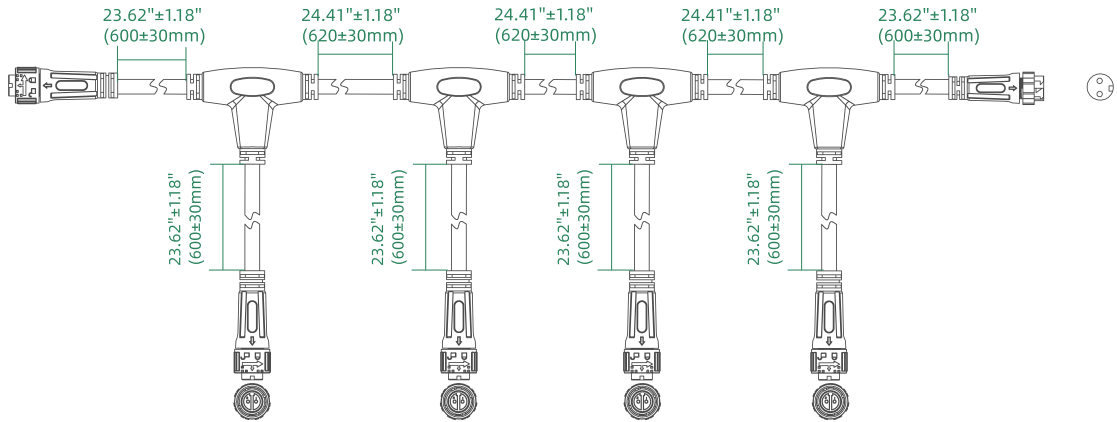

North America version Dimming T-shape junction cable, 2pin, 1 sub-5 dimming interconnection cable, totally 10.17'(380-A-0008)
 Europe version Dimming T-shape junction cable, 2pin, 1 sub-5 dimming interconnection cable, totally 3.1m(380-A-0010)

APPLICATION SCENARIOS



1 set of Model Parsys Pro with 620W installed in an area of 4'x4' (1.2mx1.2m) PAR distribution for plants cultivation.
 4'x4' (1.2mx1.2m) PAR value map captured from a complete planting area.
 This application diagram displays 2 grow tables with dimension 16'x4' (4.8mx1.2m).
 Above each grow table there installed 4 sets of 380 (8 modules in total).
 The distance between fixtures and plant canopy is 0.49' (15cm).

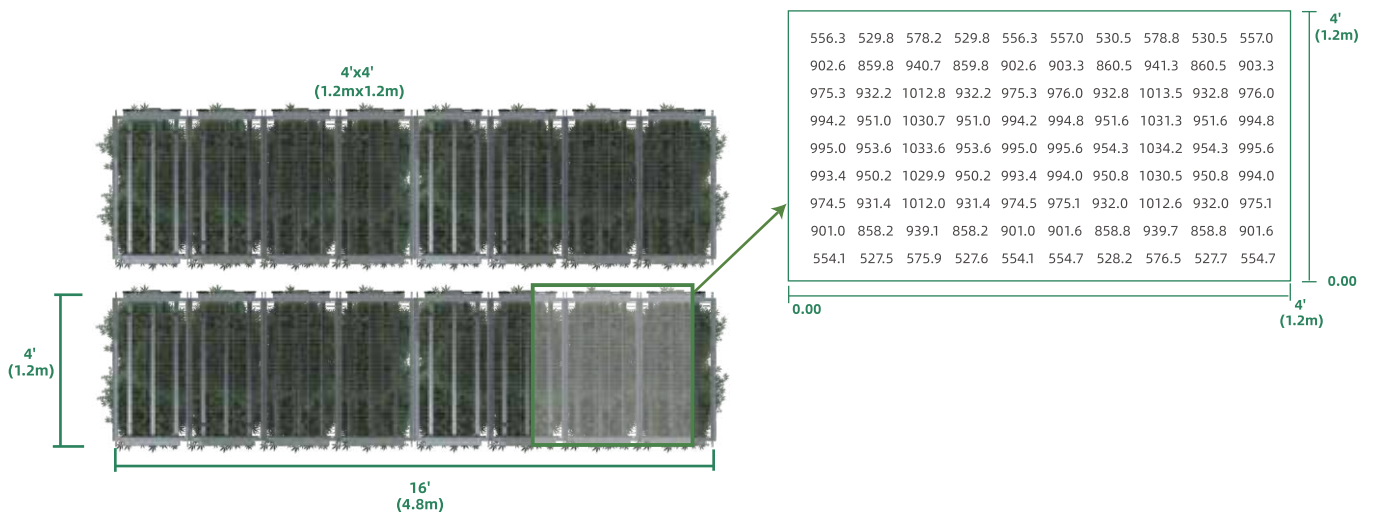



MarsEVOL

ABOUT US>>

MarsEVOL was established in 2006, 17 years of professional optoelectronic design and manufacturing experience;

With the concept of "LED-Innovation-Profession", which is one of the earliest LED lighting design manufacturers. The current product line covers Industrial and Commercial lighting, Aquarium lighting, Horticulture lighting, poultry lighting, and various professional control systems, such as Wifi, Bluetooth mesh, Zigbee.

Now MarsEVOL's solution was applied in numerous projects all over the world at all scales.



Deep Cultivation And Scientific Research

Professional R&D team, including a structural team, an electronic team, an optical team, an engineering process team, a software team, and a testing team.



Advanced Production Equipment

Full set of optical and electrical laboratories, as well as advanced factory equipments.



Strong Enterprise Strength

The earliest VDE certification was obtained in 2007. Up to now, the certifications have VDE, UL, ETL, ENEC, TUV, CE, FCC., EMC,LVD, RoHS, KC, SAA, CB and so on.



Strict Quality Control

ISO9001 quality control system, with IQC, IPQC, OQC teams and processes.



Numerous Patents

Hundreds of patents (Continue to be updated)

ABOUT OUR SMART CONTROL SYSTEM

1-HarveStation is combined by the PAD, Host controller, Par detector, Dimming Controller and Dimming Amplifier. It supports DLI automatic management, controls the dimming of fixture and develops detailed lighting strategies.

It supports lighting partition control, full cycle control, sunlight DLI data statistics, temperature and humidity data statistics. It can effectively balance sunlight and artificial lighting and save lighting energy consumption to the maximum extent.

Statistics can help growers better improve their lighting strategies and gain more productivity.



2-Compact Dimming Controller, two channels can be set, each channel can connect up to 25 lamps;

This compact dimming controller equipment includes a 100~240Vac power adapter, a dimming signal cable + pigtail dimming power cable (total length 2.5 meters/ 8.2 feet);

