



MarsEVOL



PARSYS UNI

▶ For indoor and vertical farms lighting

Product Features:

- Internal driver, max 28pcs(28W) can be daisy chained under 230V, less wiring keeps environment neat& clean.
- Multiple full spectrum for whole cultivation stage, tissue culture, cloning etc. Meet lighting demands of different plants
- Triple application clips. Flexible, convenient and rapid installation.

-  IP Level : IP66
-  Beam Angle: 120°
-  Installation: easy to install
-  Warranty: 5 Year Warranty



CB CE RoHS

— MarsEVOL LIGHTING

PRODUCT SPECTRUM



FS-Nurse

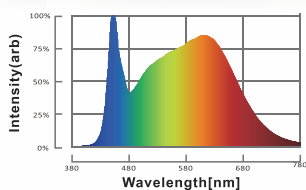

Full spectrum with blue peak.
Contains wavelengths between 400-700nm.

FS-Gro

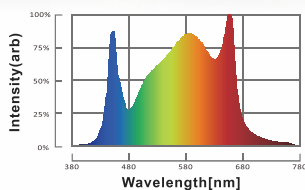

Full spectrum with deep red peak.
Contains wavelengths between 400-700nm.
Drastically enhance energy at 660nm.
Meets the needs of most plant growth.

FS-Clone

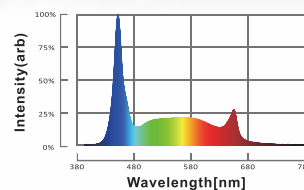

Full spectrum for the cloning and seedling stage.
Contains wavelengths between 400-700nm.
Mixed 6500k, 450nm, 660nm to enhance energy
for germinate seeds and root cuttings.

Body: Aluminum+PC Weight: 1.1lb/0.5kg

Package Dimensions: 51.57"x11.81"x11.81"(131x30x30cm)(40pcs 48.5lb/22kg)

	Type No.	Power	Efficiency	PPF	Spectrum	Voltage	BTU	Length	LED
Europe	315-0007	9W	2.2 μ mol/J	19.8 μ mol/s	FS-Nurse	220-240VAC	30.7	1200mm	Samsung White
	315-0008	28W	2.4 μ mol/J	67.2 μ mol/s	FS-Gro	220-240VAC	95.54	1200mm	Samsung White+Red
	315-0009	9W	2.3 μ mol/J	20.7 μ mol/s	FS-Gro	220-240VAC	30.7	1200mm	Samsung White+Red
	315-0010	28W	2.4 μ mol/J	67.2 μ mol/s	FS-Gro	220-240VAC	95.54	1200mm	Samsung White+Red
	315-0013	20W	2.2 μ mol/J	44 μ mol/s	FS-Clone	220-240VAC	68.24	1185mm	Samsung White + Blue +Red
	315-0019	28W	2.4 μ mol/J	67.2 μ mol/s	FS-Nurse	220-240VAC	95.54	1200mm	Samsung White
	315-0021	9W	2.2 μ mol/J	19.8 μ mol/s	FS-Nurse	220-240VAC	30.7	1200mm	Samsung White
	315-0022	9W	2.2 μ mol/J	19.8 μ mol/s	FS-Gro	220-240VAC	30.7	1200mm	Samsung White+Red
	315-0025	14W	2.3 μ mol/J	32.2 μ mol/s	FS-Gro	220-240VAC	47.76	600mm	Samsung White+Red
	315-0026	28W	2.4 μ mol/J	67.2 μ mol/s	FS-Gro	220-240VAC	95.54	1500mm	Samsung White+Red
315-0034	28W	2.8 μ mol/J	78.4 μ mol/s	FS-Gro	220-277VAC	95.54	1185mm	Samsung White+Red	
North America	315-0014	20W	2.2 μ mol/J	44 μ mol/s	FS-Clone	100-277VAC	68.24	46.65"	Samsung White + Blue +Red
	315-0015	30W	2.2 μ mol/J	66 μ mol/s	FS-Gro	100-277VAC	102.36	59.05"	Samsung White+Red
	315-0016	30W	2.2 μ mol/J	66 μ mol/s	FS-Gro	100-277VAC	102.36	46.65"	Samsung White+Red

Remark: 0.98ft (0.3m) cables on both ends of the North America versions and Europe model 315-0010, 315-0013 and 315-0034, 0.98ft (0.3m) cables on both ends of other Europe versions.





AMPERAGE BY VOLTAGE OVERVIEW

	VOLTAGE(AC)	120V	208V	230V	277V	348V	480V
Europe	315-0007	/	/	0.04A	/	/	/
	315-0008	/	/	0.12A	/	/	/
	315-0009	/	/	0.04A	/	/	/
	315-0010	/	/	0.12A	/	/	/
	315-0013	/	/	0.09A	/	/	/
	315-0019	/	/	0.12A	/	/	/
	315-0021	/	/	0.04A	/	/	/
	315-0022	/	/	0.04A	/	/	/
	315-0025	/	/	0.06A	/	/	/
	315-0026	/	/	0.12A	/	/	/
North America	315-0034	/	/	0.12A	/	/	/
	315-0014	0.17A	0.10A	/	0.07A	/	/
	315-0015	0.25A	0.14A	/	0.11A	/	/
	315-0016	0.25A	0.14A	/	0.11A	/	/

MAX CONNECTION QTY

	VOLTAGE(AC)	120V	208V	230V	277V	348V	480V
Europe	315-0007	/	/	90	/	/	/
	315-0008	/	/	28	/	/	/
	315-0009	/	/	90	/	/	/
	315-0010	/	/	28	/	/	/
	315-0013	/	/	45	/	/	/
	315-0019	/	/	28	/	/	/
	315-0021	/	/	90	/	/	/
	315-0022	/	/	90	/	/	/
	315-0025	/	/	56	/	/	/
	315-0026	/	/	28	/	/	/
North America	315-0034	/	/	28	/	/	/
	315-0014	22	44	/	59	/	/
	315-0015	15	28	/	39	/	/
	315-0016	15	28	/	39	/	/

PLUGS AT DIFFERENT VOLTAGES

North America	125V	250V	277V		Europe	230V
	5-15P	6-15P	7-15P	L7-15P		
						

PRODUCT DIMENSIONS

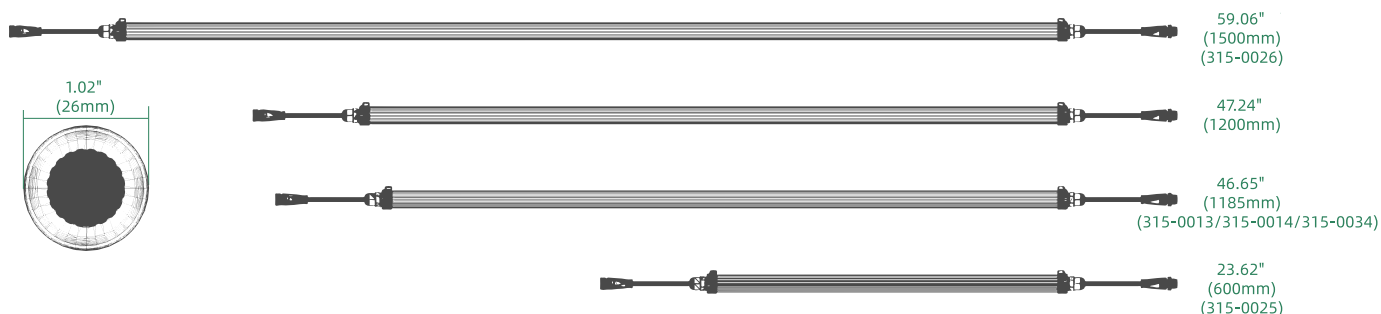

PRODUCT ACCESSORIES

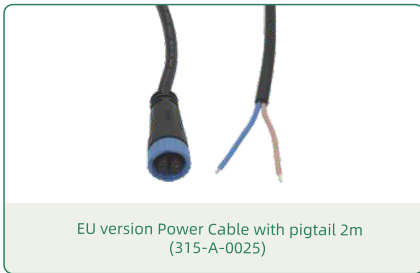
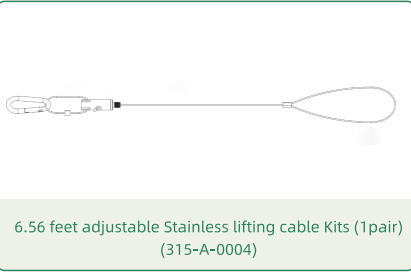

PHOTOSYNTHETIC PHOTON FLUX DENSITY

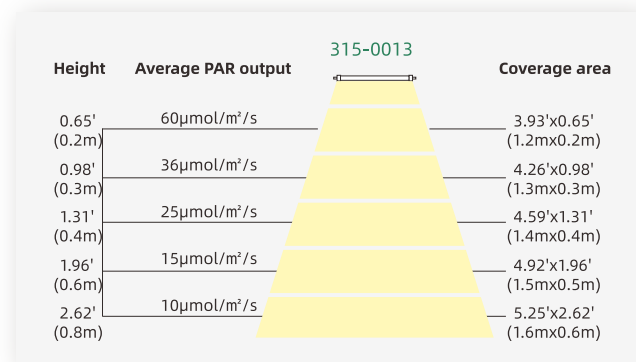
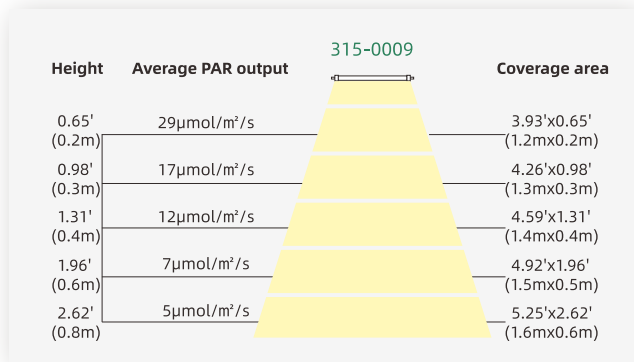
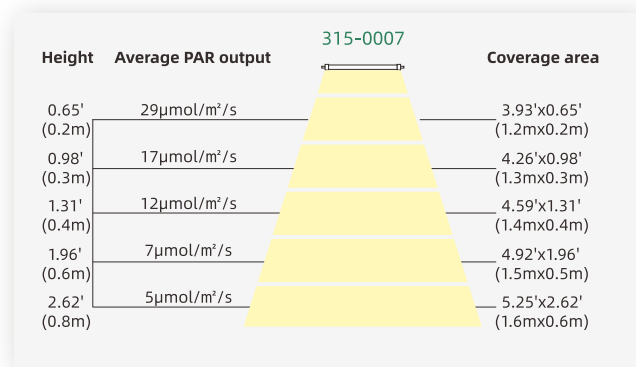
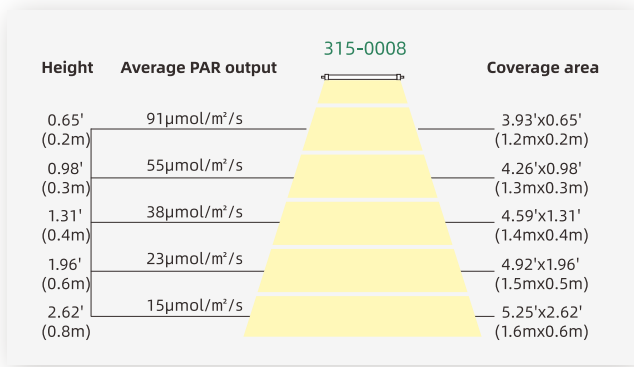

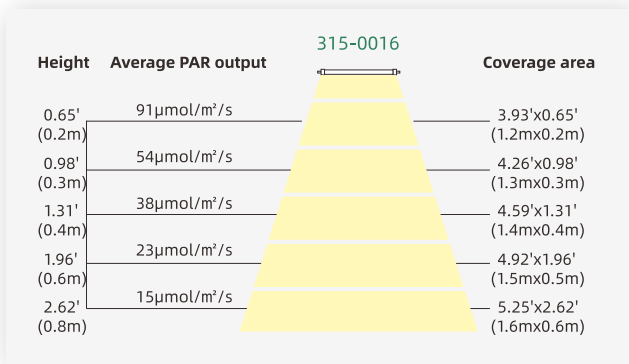

TYPICAL APPLICATION

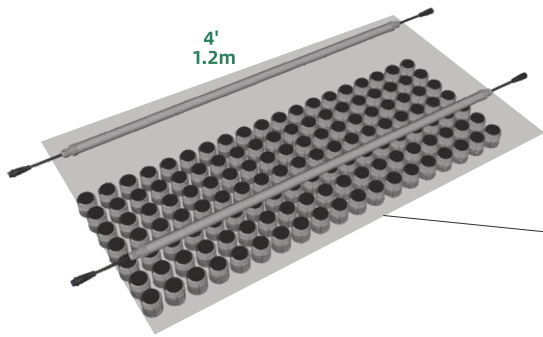

This map displays PAR distribution in an area of 4'x2'(1.2mx0.6m). The distance between the lights and the plants is 0.98'(0.30m), and 2pcs 315-0007 are needed in the planting area of 4'x2'(1.2mx0.6m).

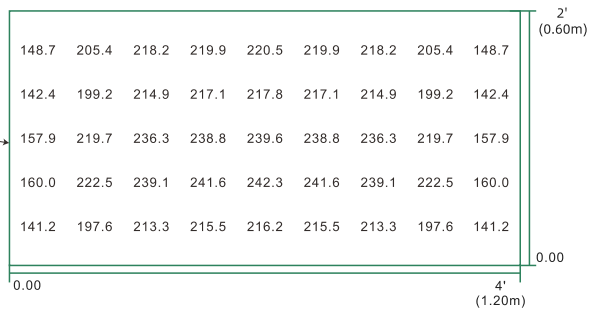
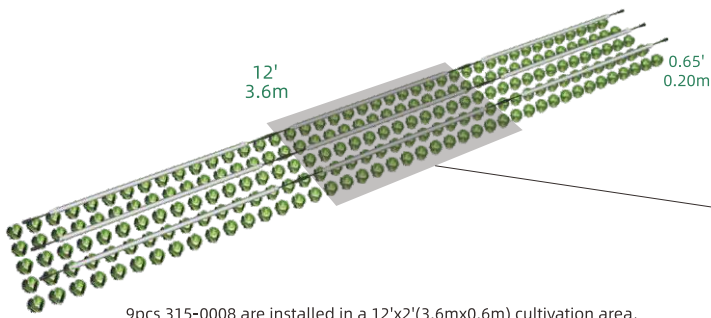

9pcs 315-0008 are installed in a 12'x2'(3.6mx0.6m) cultivation area, the PAR distribution of 3pcs in the middle area 4'x2'(1.2mx0.6m) is shown as:



MarsEVOL

ABOUT US>>

MarsEVOL was established in 2006, 17 years of professional optoelectronic design and manufacturing experience;

With the concept of "LED-Innovation-Profession", which is one of the earliest LED lighting design manufacturers. The current product line covers Industrial and Commercial lighting, Aquarium lighting, Horticulture lighting, poultry lighting, and various professional control systems, such as Wifi, Bluetooth mesh, Zigbee.

Now MarsEVOL's solution was applied in numerous projects all over the world at all scales.



Deep Cultivation And Scientific Research

Professional R&D team, including a structural team, an electronic team, an optical team, an engineering process team, a software team, and a testing team.



Advanced Production Equipment

Full set of optical and electrical laboratories, as well as advanced factory equipments.



Strong Enterprise Strength

The earliest VDE certification was obtained in 2007. Up to now, the certifications have VDE, UL, ETL, ENEC, TUV, CE, FCC, EMC, LVD, RoHS, KC, SAA, CB and so on.



Strict Quality Control

ISO9001 quality control system, with IQC, IPQC, OQC teams and processes.



Numerous Patents

Hundreds of patents (Continue to be updated)

ABOUT OUR SMART CONTROL SYSTEM

1-HarveStation is combined by the PAD, Host controller, Par detector, Dimming Controller and Dimming Amplifier. It supports DLI automatic management, controls the dimming of fixture and develops detailed lighting strategies.

It supports lighting partition control, full cycle control, sunlight DLI data statistics, temperature and humidity data statistics. It can effectively balance sunlight and artificial lighting and save lighting energy consumption to the maximum extent.

Statistics can help growers better improve their lighting strategies and gain more productivity.



2-Compact Dimming Controller, two channels can be set, each channel can connect up to 25 lamps;

This compact dimming controller equipment includes a 100~240Vac power adapter, a dimming signal cable + pigtail dimming power cable (total length 2.5 meters / 8.2 feet);

