

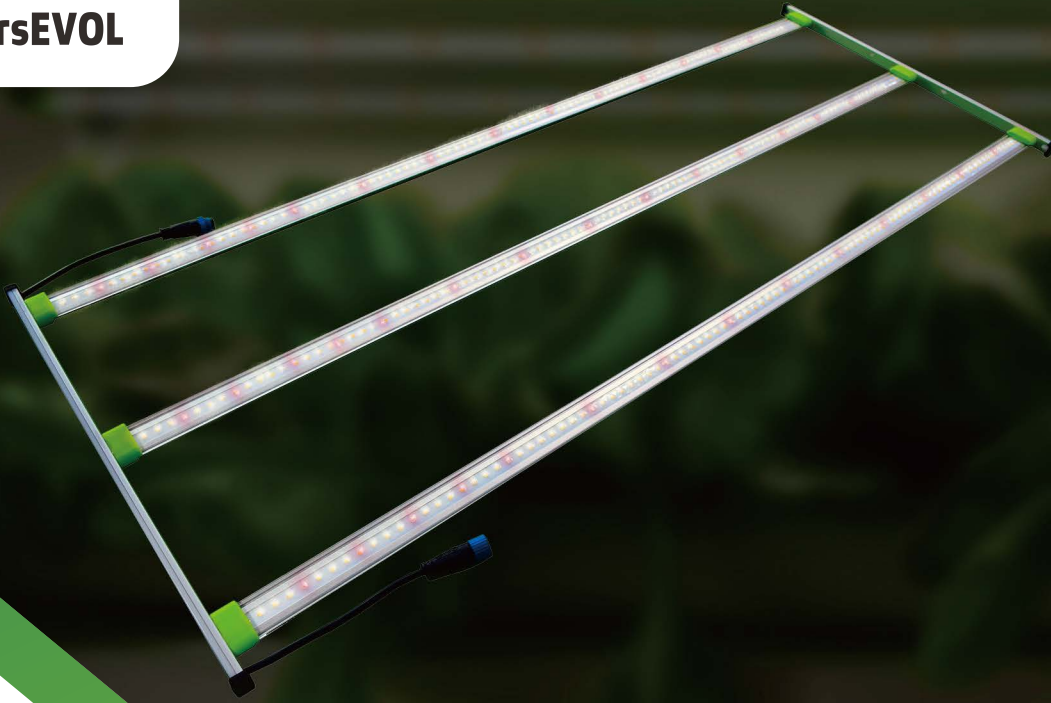

MarsEVOL



PARSYS STAR

► For vertical farms/grow towers/zipper systems/grow walls/containers

Product Features:

- Ultra-thin design with 0.14 inch/10.5mm, saving more grow space; External driver for easy thermal management
- Full spectrum covers 400-700nm, suitable for all plant cultivation; 0-10V dimming, meeting different PPFD requirements of plants in different stages
- Most cost-effective standard efficiency 2.4 μ mol/J, can be customized over 3.0 μ mol/J.

-  Protection Level: IP66
-  Beam Angle: 120°
-  Warranty: 5 Year
-  Dimming Type: 0-10V



CB CE RoHS

— MarsEVOL LIGHTING

PRODUCT PARAMETERS

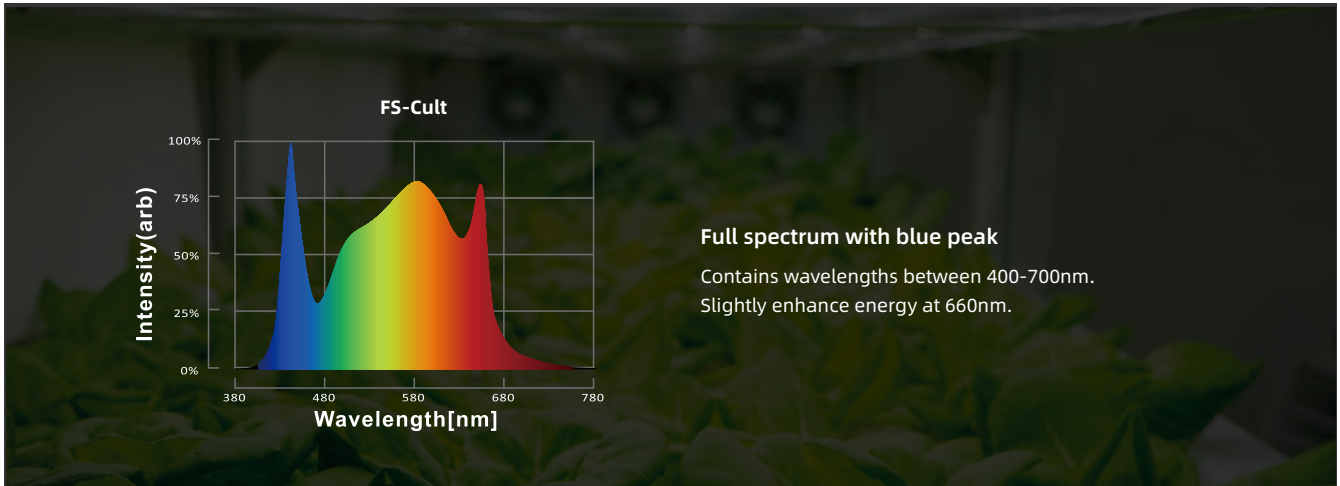





PRODUCT PARAMETER DETAILS

	Type NO.	Power	Efficiency	PPF	BTU	Spectrum	Voltage	LED	Certificate No.	Mark
North America	367-0022	600W	2.3 μ mol/J	1440 μ mol/s	2047.28	FS-Cult	100-277VAC	Samsung White + Nationstar Red	367-600-6-FA	
	367-0008	500W	2.3 μ mol/J	1200 μ mol/s	1706.07	FS-Cult	100-277VAC	Samsung White + Nationstar Red	367-480-5-FA	
	367-0010	400W	2.3 μ mol/J	960 μ mol/s	1364.86	FS-Cult	100-277VAC	Samsung White + Nationstar Red	367-480-4-FA	
	367-0033	300W	2.3 μ mol/J	720 μ mol/s	1023.64	FS-Cult	100-277VAC	Samsung White + Nationstar Red	/	/
	367-0029	100W	2.3 μ mol/J	240 μ mol/s	341.21	FS-Cult	100-277VAC	Samsung White + Nationstar Red	/	/
Europe	367-0039	800W	2.4 μ mol/J	1920 μ mol/s	2729.71	FS-Cult	100-240VAC	Samsung White + Nationstar Red	367-0039	CE
	367-0034	600W	2.4 μ mol/J	1440 μ mol/s	2047.28	FS-Cult	100-240VAC	Samsung White + Nationstar Red	367-0034	CE CB
	367-0035	500W	2.4 μ mol/J	1200 μ mol/s	1706.07	FS-Cult	100-240VAC	Samsung White + Nationstar Red	367-0035	CE
	367-0036	400W	2.4 μ mol/J	960 μ mol/s	1364.86	FS-Cult	100-240VAC	Samsung White + Nationstar Red	367-0036	CE
	367-0033	300W	2.4 μ mol/J	720 μ mol/s	1023.64	FS-Cult	100-240VAC	Samsung White + Nationstar Red	367-0033	CE
	367-0029	100W	2.4 μ mol/J	240 μ mol/s	341.21	FS-Cult	100-240VAC	Samsung White + Nationstar Red	367-0029	CE CB

AMPERAGE BY VOLTAGE OVERVIEW

		VOLTAGE(AC)	120V	208V	230V	277V	348V	480V
AMPERAGE	North America	367-0022	5.00A	2.88A	/	2.17A	/	/
		367-0008	4.17A	2.40A	/	1.81A	/	/
		367-0010	3.33A	1.92A	/	1.44A	/	/
		367-0033	2.50A	1.44A	/	1.08A	/	/
		367-0029	0.83A	0.47A	/	0.36A	/	/
	Europe	367-0039	/	/	3.48A	/	/	/
		367-0034	/	/	2.61A	/	/	/
		367-0035	/	/	2.17A	/	/	/
		367-0036	/	/	1.74A	/	/	/
		367-0033	/	/	1.30A	/	/	/
		367-0029	/	/	0.43A	/	/	/

PLUGS AT DIFFERENT VOLTAGES

North America	125V	250V	277V		Europe	230V
	5-15P	6-15P	7-15P	L7-15P		
						

PRODUCT DIMENSIONS

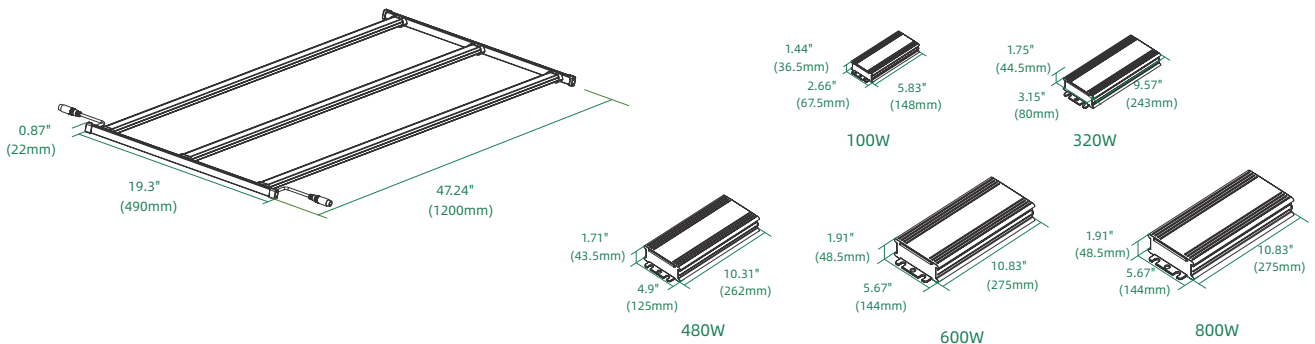

PRODUCT ACCESSORIES

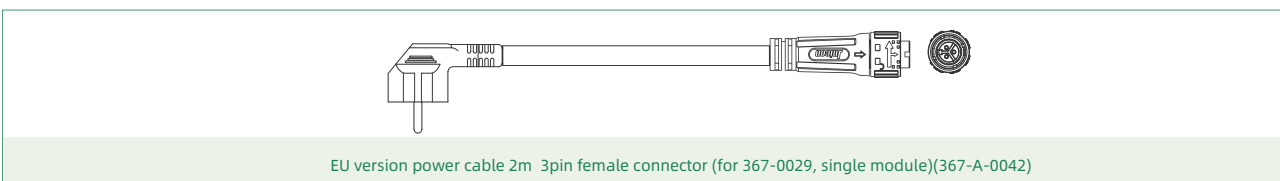
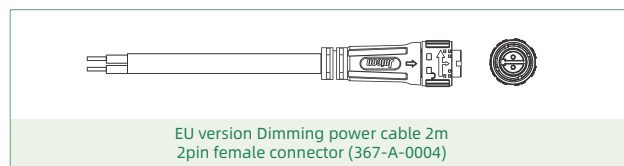
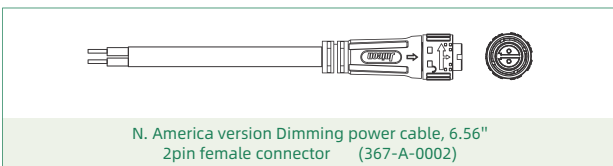
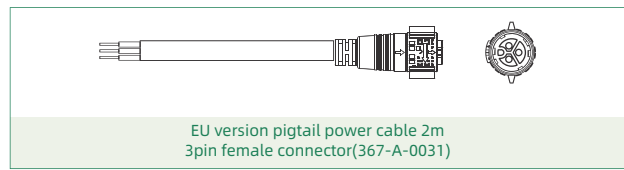
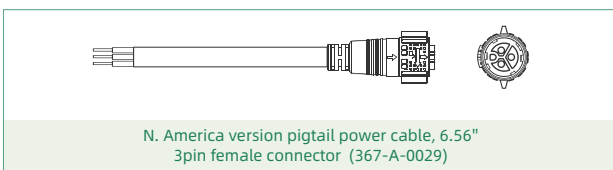
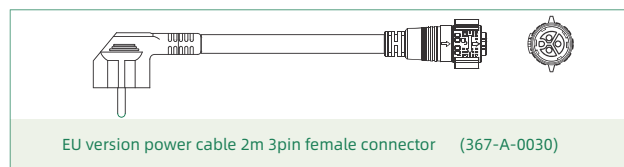
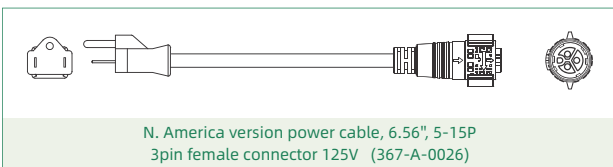

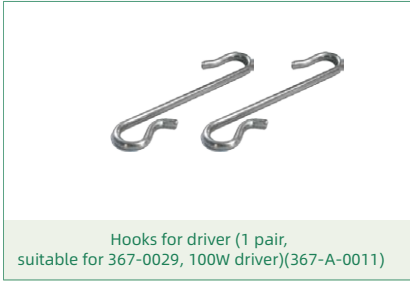

Hooks for driver (1 pair, suitable for 367-0029, 100W driver)(367-A-0011)



Stainless clips + stainless cables Installation kits suitable for shelves except CC rack(367-A-0012)

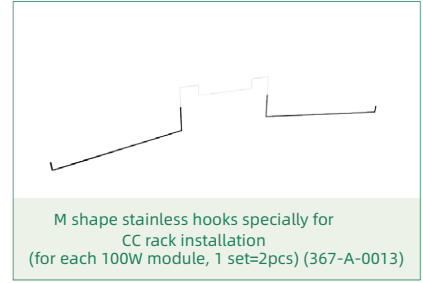

M shape stainless hooks specially for CC rack installation (for each 100W module, 1 set=2pcs) (367-A-0013)



M16 waterproof end cap for Dimming power cable(367-A-0016)



Mounting installation screws kits for driver (367-A-0064)

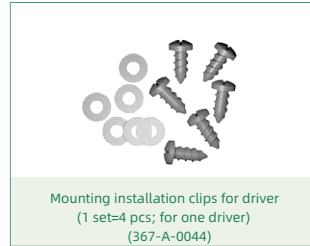

Mounting installation clips for driver (1 set=4 pcs; for one driver) (367-A-0044)



Mounting installation clips for modules (1 set=4 pcs; for one module) (367-A-0045)

PHOTOSYNTHETIC PHOTON FLUX DENSITY



TYPICAL APPLICATION

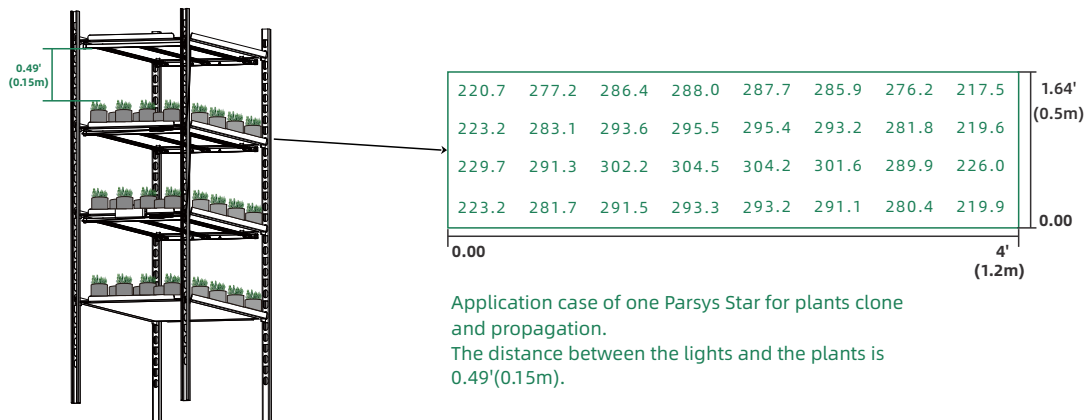



MarsEVOL

ABOUT US>>

MarsEVOL was established in 2006, 17 years of professional optoelectronic design and manufacturing experience;

With the concept of “**LED-Innovation-Profession**”, which is one of the earliest LED lighting design manufacturers. The current product line covers Industrial and Commercial lighting, Aquarium lighting, Horticulture lighting, poultry lighting, and various professional control systems, such as Wifi, Bluetooth mesh, Zigbee.

Now **MarsEVOL**'s solution was applied in numerous projects all over the world at all scales.



Deep Cultivation And Scientific Research

Professional R&D team, including a structural team, an electronic team, an optical team, an engineering process team, a software team, and a testing team.



Advanced Production Equipment

Full set of optical and electrical laboratories, as well as advanced factory equipments.



Strong Enterprise Strength

The earliest VDE certification was obtained in 2007. Up to now, the certifications have VDE, UL, ETL, ENEC, TUV, CE, FCC., EMC,LVD, RoHS, KC, SAA, CB and so on.



Strict Quality Control

ISO9001 quality control system, with IQC, IPQC, OQC teams and processes.



Numerous Patents

Hundreds of patents (Continue to be updated)

ABOUT OUR SMART CONTROL SYSTEM

1-HarveStation is combined by the PAD, Host controller, Par detector, Dimming Controller and Dimming Amplifier. It supports DLI automatic management, controls the dimming of fixture and develops detailed lighting strategies.

It supports lighting partition control, full cycle control, sunlight DLI data statistics, temperature and humidity data statistics. It can effectively balance sunlight and artificial lighting and save lighting energy consumption to the maximum extent.

Statistics can help growers better improve their lighting strategies and gain more productivity.



2-Compact Dimming Controller, two channels can be set, each channel can connect up to 25 lamps;

This compact dimming controller equipment includes a 100~240Vac power adapter, a dimming signal cable + pigtail dimming power cable (total length 2.5 meters/ 8.2 feet);

