



**MarsEVOL**

External driver 1135W



# PARSYS ARRAY

▶ For vertical farming

## Product Features:

- External driver 1135W drive 28pcs lamps, flexible combination.
  - Driver with 0-10V dimming can be centralized installation, saving wiring and installing, easy management on heating.
  - For vertical farm with multiple layers planting, plug and play, flexible installation methods.
  - Spectrum is suitable for all the leafy greens.
  - IP66, 5 years warranty.
  - Match LEDINPRO controller to simulate daylight change, achieve photoperiod and dimming function management automatically.
- ☀ Efficiency: 2.5 $\mu$ mol/J
  - ☀ PPF: 101 $\mu$ mol/s<sub>(Maximum per lamp)</sub>
  - 🛡 Warranty: 5 year
  - 🌀 Cooling Type: Passive
  - 🌞 Diming Type: 0-10V



**CB CE RoHS**

— MarsEVOL LIGHTING

# PRODUCT PARAMETERS

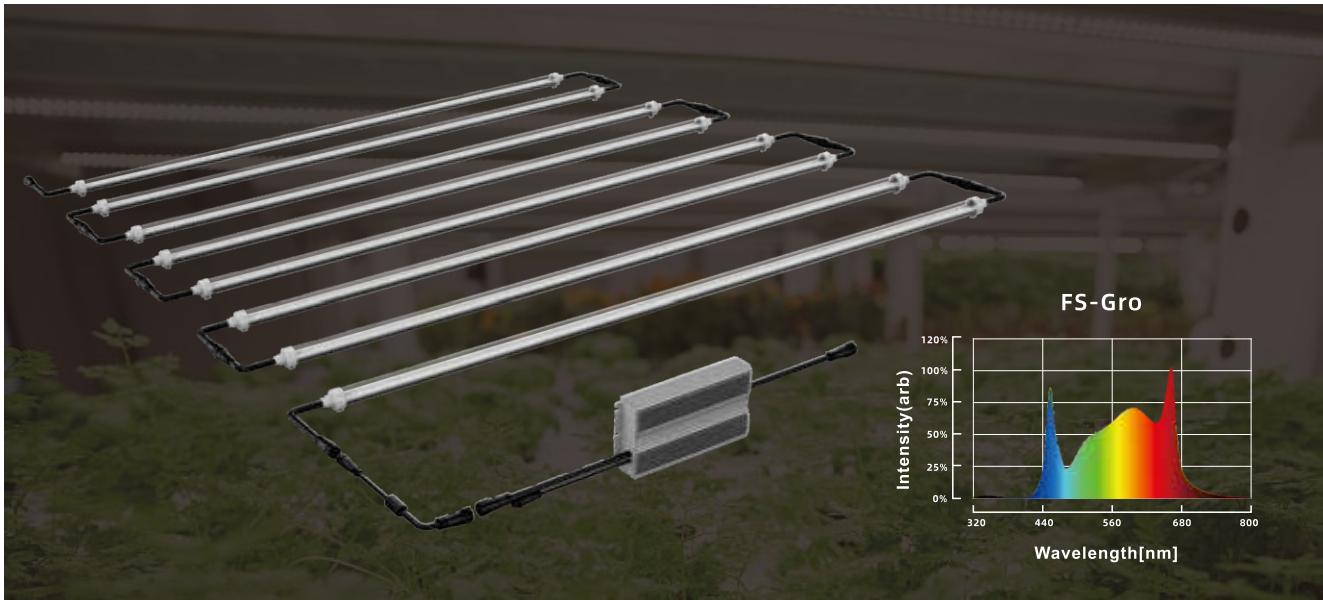





	Type NO.	Power	Efficiency	PPF	Spectrum	Dimming	Voltage	Warranty	BTU	LED
North America	497-0002	560W	2.5µmol/J	1400µmol/s	FS-Gro	0-10V	100-277V	7 year	164.1	Samsung2835 4000K+ LEDStar 2835 660nm
	497-0004	840W	2.5µmol/J	2100µmol/s	FS-Gro	0-10V	100-277V	5 year	246.1	Samsung2835 4000K+ LEDStar 2835 660nm
	497-0006	1135W	2.5µmol/J	2837.5µmol/s	FS-Gro	0-10V	277-480V	5 year	332.6	Samsung2835 4000K+ LEDStar 2835 660nm
Europe	497-0001	560W	2.5µmol/J	1400µmol/s	FS-Gro	0-10V	100-240V	7 year	164.1	Samsung2835 4000K+ LEDStar 2835 660nm
	497-0003	840W	2.5µmol/J	2100µmol/s	FS-Gro	0-10V	100-240V	5 year	246.1	Samsung2835 4000K+ LEDStar 2835 660nm
	497-0005	1135W	2.5µmol/J	2837.5µmol/s	FS-Gro	0-10V	277-480V	5 year	332.6	Samsung2835 4000K+ LEDStar 2835 660nm

# AMPERAGE BY VOLTAGE OVERVIEW

		VOLTAGE(AC)	120V	208V	230V	277V	348V	400V	480V
AMPERAGE	North America	497-0002	4.7A	/	/	2.1A	/	/	/
		497-0004	7.1A	/	/	3.1A	/	/	/
		497-0006	/	/	/	4.1A	/	/	2.4A
	Europe	497-0001	/	/	2.5A	/	/	/	/
		497-0003	/	/	3.7A	/	/	/	/
		497-0005	/	/	/	/	/	2.85A	/

# PLUGS AT DIFFERENT VOLTAGES

North America	125V	250V	277V		Europe	230V
	5-15P	6-15P	7-15P	L7-15P		
						

# PRODUCT DIMENSIONS

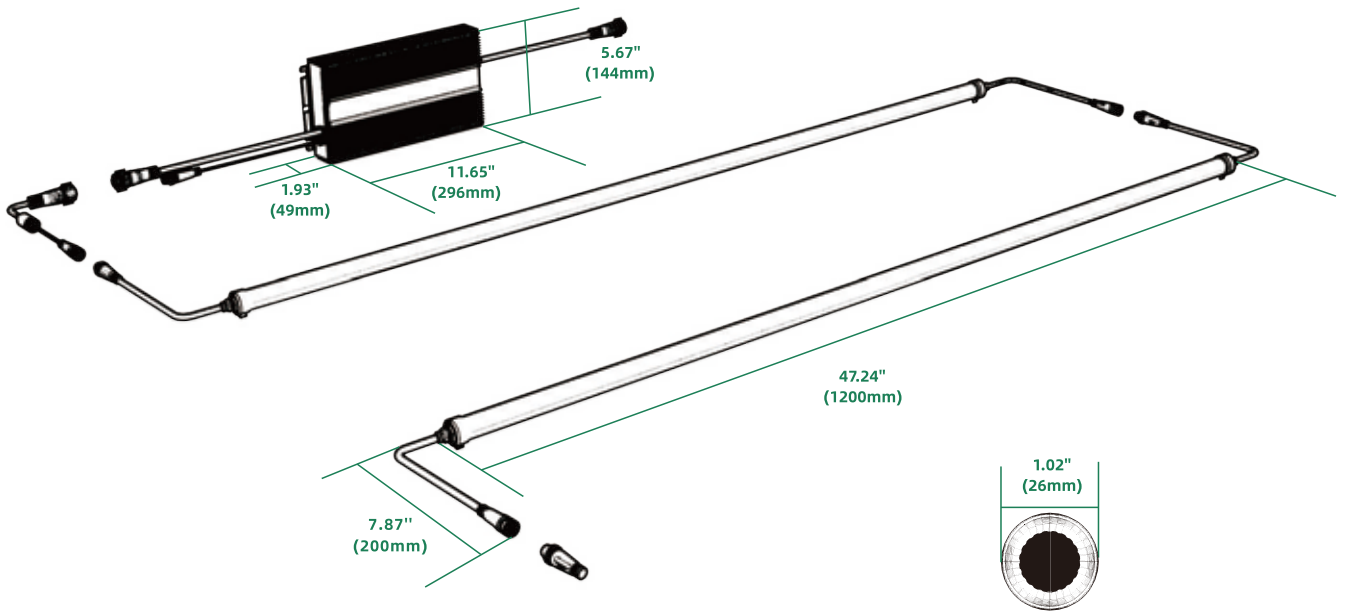

**Body:** Aluminum+PC **Weight:** 4.4lb/13.4kg

**Package Dimensions:** 20.5"X2.7"x2.0" (520\*70\*50mm)(40 pieces)

# PRODUCT ACCESSORIES



North America version power cable  
6.56 feet 3\*14AWG, 3pin, female  
connector, 5-15P(446-A-0001).



EU version power cable 2m 3\*1.5mm<sup>2</sup>, 3pin,  
female connector+EU version plug  
(446-A-0004).



EU version Dimming power cable  
2m 2\*1.0mm<sup>2</sup>, 2pin,  
female connector (446-A-0006).  
North America version Dimming power  
cable 6.56 feet 2\*18AWG, 2pin,  
female connector (446-A-0005).



EU version - pigtail power cable 2m  
3\*1.5mm<sup>2</sup>, 3pin, female connector  
(446-A-0003).  
North America version - pigtail power  
cable 6.56 feet 3\*14AWG, 3pin, female  
connector. (446-A-0002)



Stainless clips with gum cover for driver  
installation (1 pair)(497-A-0008).



"I" shape Installation kits for driver  
(497-A-0002).



New stainless steel ceiling mounting clips  
(a pair)(497-A-0001).



M16 waterproof for dimming cable of driver  
(for male connector). (446-A-0009).

# APPLICATION SCENARIOS



Vertical farming & Indoor farming

# TYPICAL APPLICATION

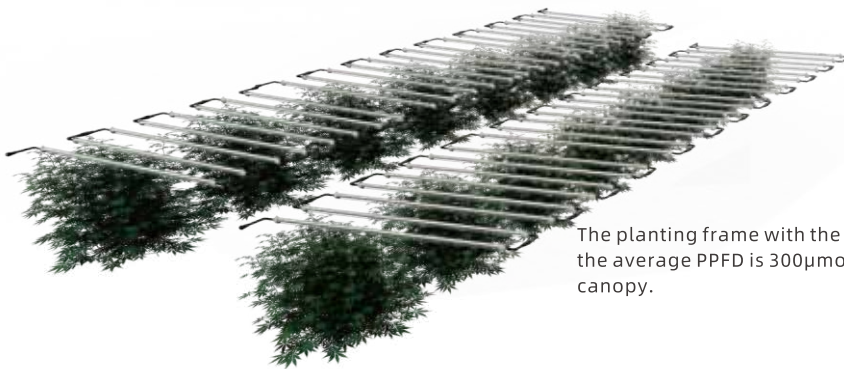

The planting frame with the name of 1.2x4.8m(4'X8') is installed with 28 lamps, the average PPFD is 300 $\mu$ mol/m<sup>2</sup>/s when the distance is 15cm (5.9") above the canopy.

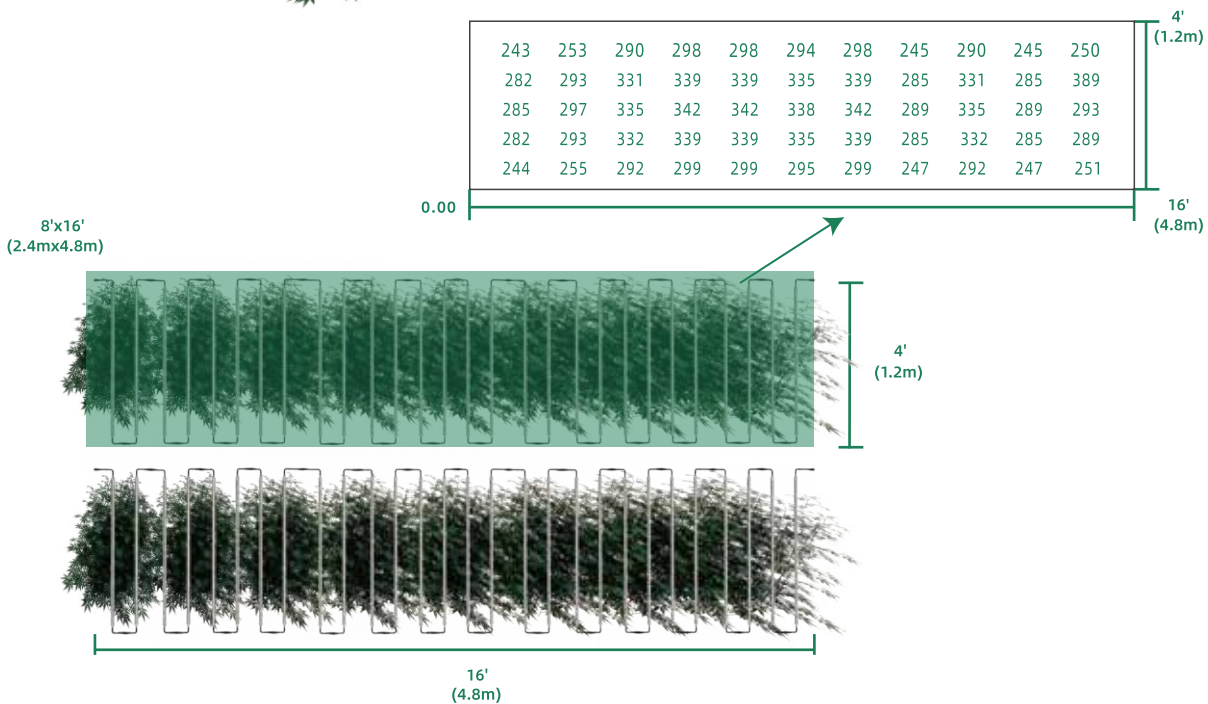



**MarsEVOL**

## ABOUT US>>

MarsEVOL was established in 2006, 17 years of professional optoelectronic design and manufacturing experience;

With the concept of "LED-Innovation-Profession", which is one of the earliest LED lighting design manufacturers. The current product line covers Industrial and Commercial lighting, Aquarium lighting, Horticulture lighting, poultry lighting, and various professional control systems, such as Wifi, Bluetooth mesh, Zigbee.

Now MarsEVOL's solution was applied in numerous projects all over the world at all scales.



### Deep Cultivation And Scientific Research

Professional R&D team, including a structural team, an electronic team, an optical team, an engineering process team, a software team, and a testing team.



### Advanced Production Equipment

Full set of optical and electrical laboratories, as well as advanced factory equipments.



### Strong Enterprise Strength

The earliest VDE certification was obtained in 2007. Up to now, the certifications have VDE, UL, ETL, ENEC, TUV, CE, FCC., EMC,LVD, RoHS, KC, SAA, CB and so on.



### Strict Quality Control

ISO9001 quality control system, with IQC, IPQC, OQC teams and processes.



### Numerous Patents

Hundreds of patents (Continue to be updated)

## ABOUT OUR SMART CONTROL SYSTEM

**1-HarveStation** is combined by the PAD, Host controller, Par detector, Dimming Controller and Dimming Amplifier. It supports DLI automatic management, controls the dimming of fixture and develops detailed lighting strategies.

It supports lighting partition control, full cycle control, sunlight DLI data statistics, temperature and humidity data statistics. It can effectively balance sunlight and artificial lighting and save lighting energy consumption to the maximum extent.

Statistics can help growers better improve their lighting strategies and gain more productivity.



**2-Compact Dimming Controller**, two channels can be set, each channel can connect up to 25 lamps;

This compact dimming controller equipment includes a 100~240Vac power adapter, a dimming signal cable + pigtail dimming power cable (total length 2.5 meters/ 8.2 feet);

