

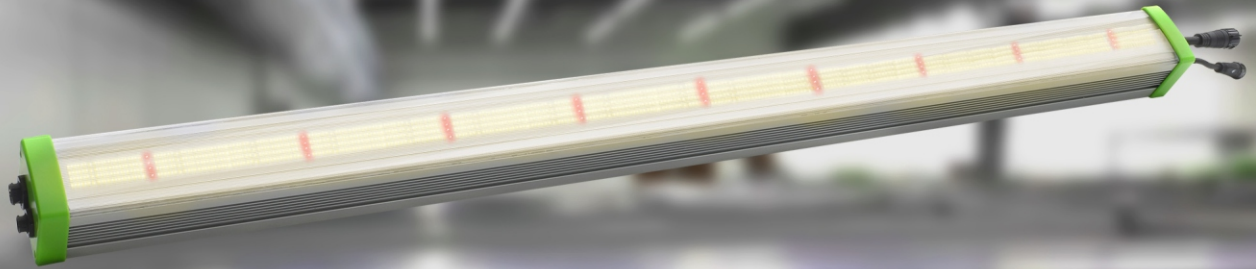

MarsEVOL



SOLIFY UNI

▶ For greenhouse and indoor farm

Product Features:

- Both full spectrum 400-700nm and red+ blue spectrum are available, meet the needs of most plants, and match with customized UV+ FR or Floraid 363 UV + FR
- Self-locking plug, direct interconnection
- Multi-shape installation hook: unistrut, square, round
- Linear design, shadow free, sunlight-resistant light body
- Adjustable length of dimming cable and power cable

- 🌿 Protection Level: IP66
- 📐 Beam Angle: 110°
- 🛡️ Warranty: 5 Year
- 🔧 Dimming Type: 0-10V



CB CE RoHS

— MarsEVOL LIGHTING

PRODUCT PARAMETERS

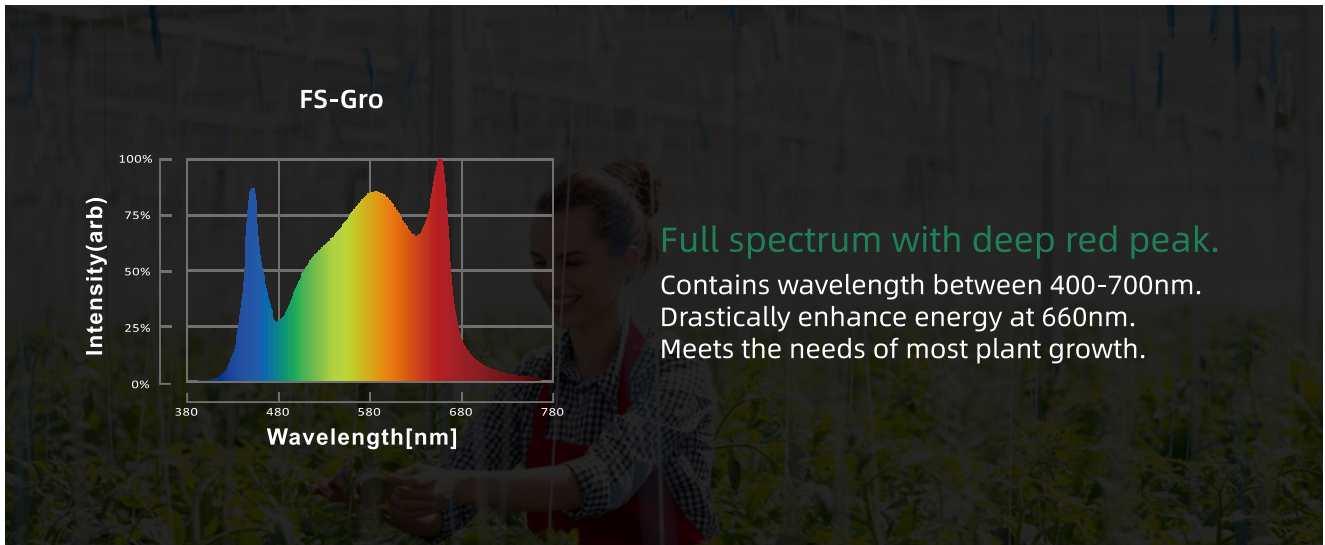

PRODUCT PARAMETER DETAILS

	Type No.	Power	Efficiency	PPF	Spectrum	Voltage	Dimming	BTU	Driver	LED
North America	350-0001	190W	2.3 μ mol/J	437 μ mol/s	FS-Gro	120-277VAC	1-10V	648.3	Philips	Samsung White+Osram Red
Europe	350-0012	190W	2.4 μ mol/J	456 μ mol/s	FS-Gro	120-240VAC	0-10V	648.3	LeDinPro	Samsung White+Osram Red
Europe	350-0013	170W	2.7 μ mol/J	459 μ mol/s	FS-Gro	120-240VAC	0-10V	648.3	LeDinPro	Osram Red+Osram blue





AMPERAGE BY VOLTAGE OVERVIEW

		VOLTAGE(AC)	120V	208V	230V	277V	348V	480V
AMPERAGE	North America	350-0001	1.58A	0.91A	/	0.69A	/	/
	Europe	350-0012	/	/	0.83A	/	/	/
		350-0013	/	/	0.74A	/	/	/

MAX CONNECTION QTY

	VOLTAGE(AC)	120V	208V	230V	277V
North America	350-0001	6	12	/	14
Europe	350-0012	/	/	11	/
	350-0013	/	/	12	/

PLUGS AT DIFFERENT VOLTAGES

North America	125V	250V	277V		Europe	230V
	5-15P	6-15P	7-15P	L7-15P		
						

PRODUCT DIMENSIONS

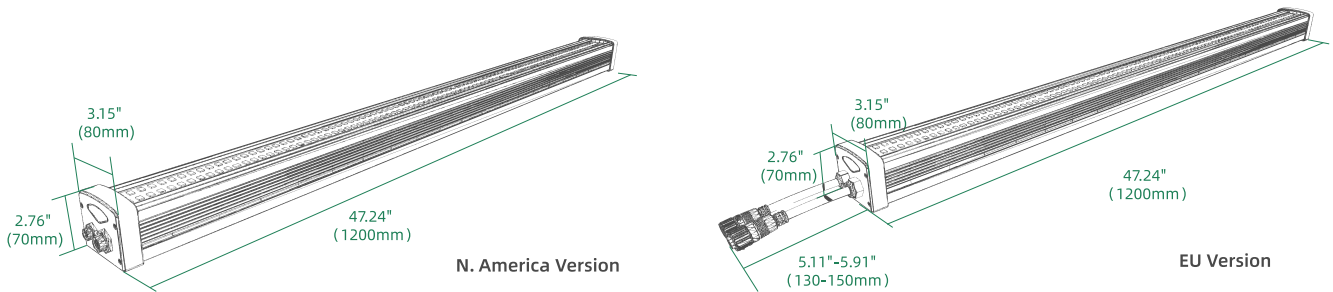

PRODUCT ACCESSORIES

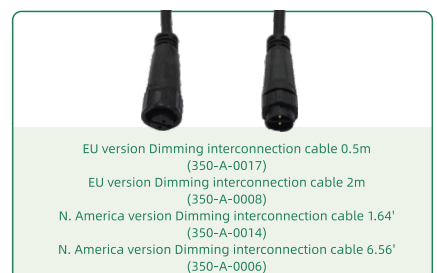
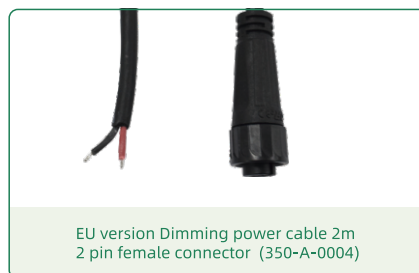
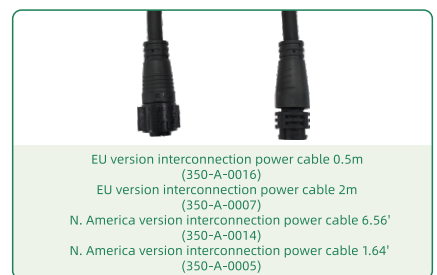



M19 end cap for power cable
(For female connector)(350-A-0022)



M19 end cap for power cable
(For female connector)(350-A-0030)



M16 end cap for dimming power cable
(for female connector)(350-A-0023)



M16 end cap for dimming power cable
(for both female connector and
male connector)(350-A-0024)



6.56'(2m) adjustable stainless steel
lifting cable 1 set=2pcs (1 pair)
(350-A-0021)



Installation hook, round shape
[dia.:1.46"(37mm)], 1 pair (350-A-0011)

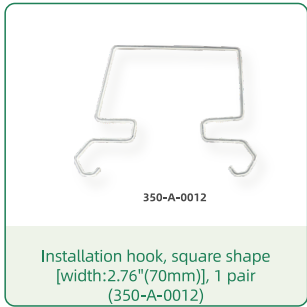

Installation hook, square shape
[width:2.76"(70mm)], 1 pair
(350-A-0012)

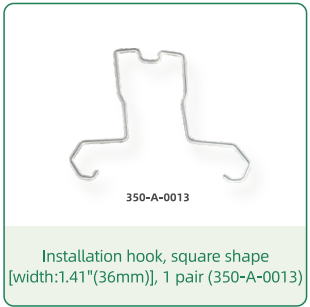

Installation hook, square shape
[width:1.41"(36mm)], 1 pair (350-A-0013)

PHOTOSYNTHETIC PHOTON FLUX DENSITY

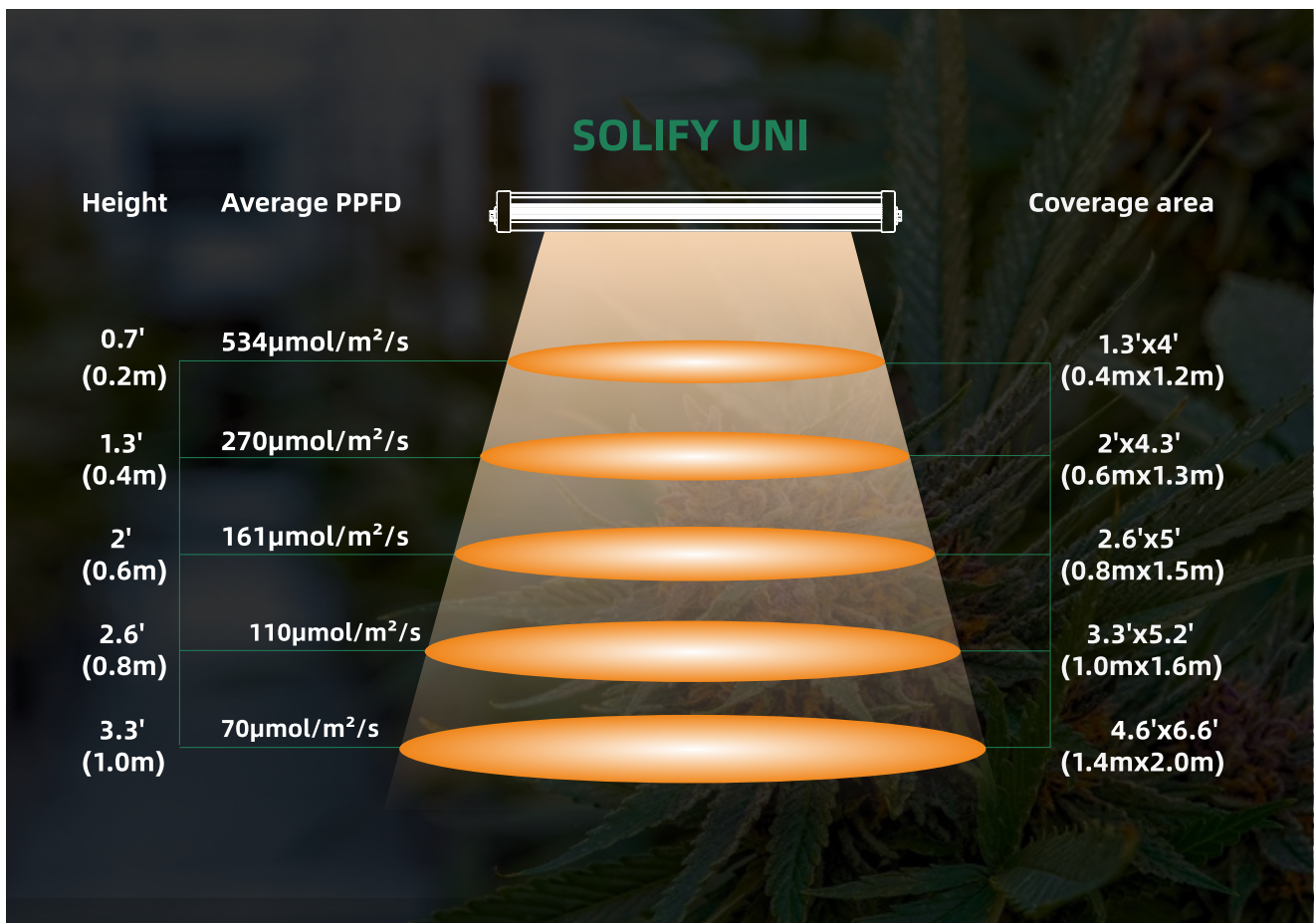

TYPICAL APPLICATION

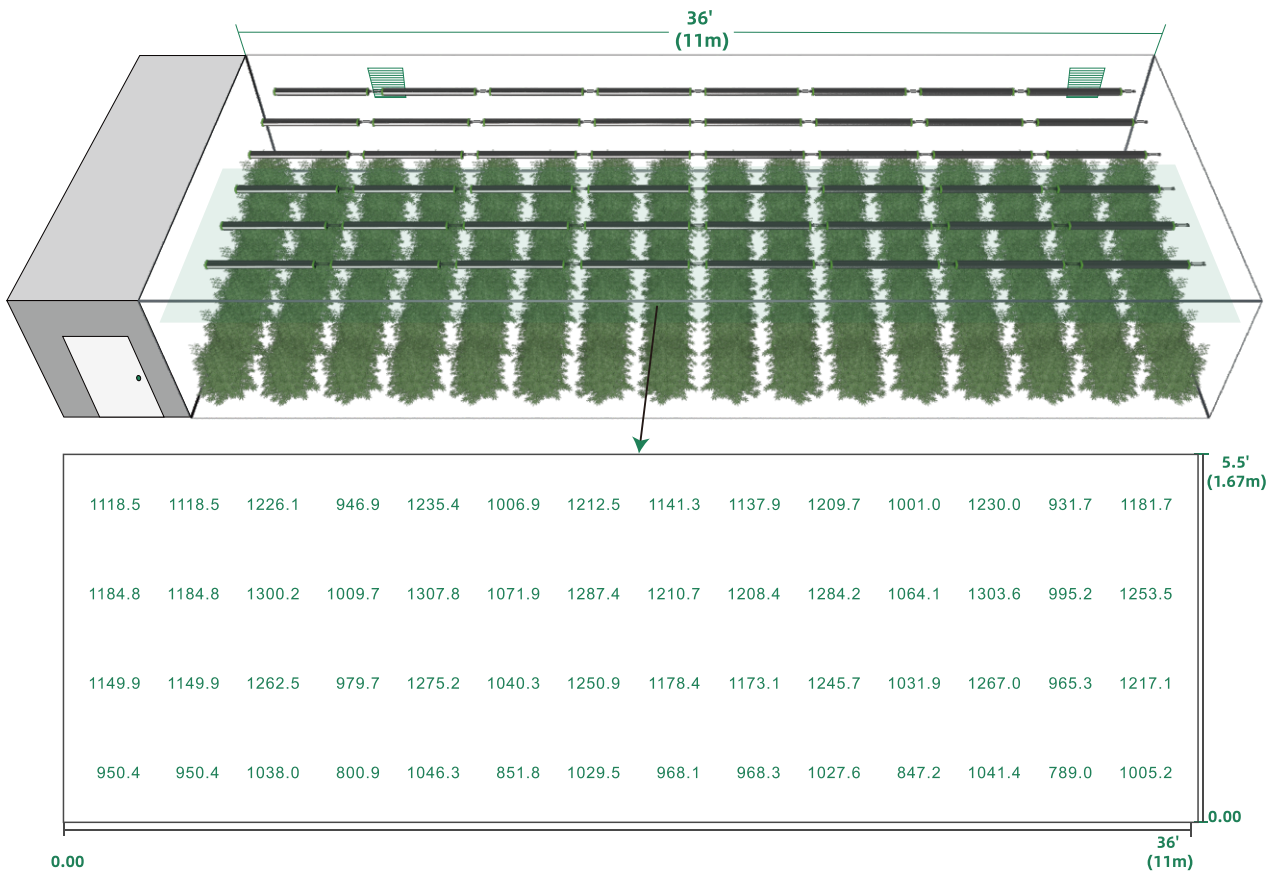

48pcs of Model SOLIFY UNI installed in a 40' container offers high PAR with high uniformity. The distance between lighting surface and the canopy of plant is 2.62'(0.8m).



MarsEVOL

ABOUT US>>

MarsEVOL was established in 2006, 17 years of professional optoelectronic design and manufacturing experience;

With the concept of “**LED-Innovation-Profession**”, which is one of the earliest LED lighting design manufacturers. The current product line covers Industrial and Commercial lighting, Aquarium lighting, Horticulture lighting, poultry lighting, and various professional control systems, such as Wifi, Bluetooth mesh, Zigbee.

Now **MarsEVOL**'s solution was applied in numerous projects all over the world at all scales.



Deep Cultivation And Scientific Research

Professional R&D team, including a structural team, an electronic team, an optical team, an engineering process team, a software team, and a testing team.



Advanced Production Equipment

Full set of optical and electrical laboratories, as well as advanced factory equipments.



Strong Enterprise Strength

The earliest VDE certification was obtained in 2007. Up to now, the certifications have VDE, UL, ETL, ENEC, TUV, CE, FCC., EMC,LVD, RoHS, KC, SAA, CB and so on.



Strict Quality Control

ISO9001 quality control system, with IQC, IPQC, OQC teams and processes.



Numerous Patents

Hundreds of patents (Continue to be updated)

ABOUT OUR SMART CONTROL SYSTEM

1-HarveStation is combined by the PAD, Host controller, Par detector, Dimming Controller and Dimming Amplifier. It supports DLI automatic management, controls the dimming of fixture and develops detailed lighting strategies.

It supports lighting partition control, full cycle control, sunlight DLI data statistics, temperature and humidity data statistics. It can effectively balance sunlight and artificial lighting and save lighting energy consumption to the maximum extent.

Statistics can help growers better improve their lighting strategies and gain more productivity.



2-Compact Dimming Controller, two channels can be set, each channel can connect up to 25 lamps;

This compact dimming controller equipment includes a 100~240Vac power adapter, a dimming signal cable + pigtail dimming power cable (total length 2.5 meters/ 8.2 feet);

